

GSM/GPRS/GPS Tracker

User Manual



Preface

Thank you for purchasing the tracker. This manual shows how to operate the device smoothly and correctly. Make sure to read this manual carefully before using this product. Please note that specification and information are subject to changes without prior notice in this manual. Any change will be integrated in the latest release. The manufacturer assumes no responsibility for any errors or omissions in this document.

Contents

1. Summary.....	4
2. Applications.....	4
3. Hardware Description	4
4. Accessories	5
5. Specifications	5
6. Usage	6
6.1 Terminal Installation.....	6
6.2SIM CARD Installations	7
6.3 Turn on the Tracker Device.....	7
6.4 GSM/GPS LED Indicator	7
6.5 Initialization	7
6.6 Change Password.....	8
6.7 Authorization.....	8
6.8 Single Locating	9
6.9 Auto track continuously	10
6.10 Automatic update positions of vehicle turns	11
6.11 GPS drift suppression	11
6.12 Absolute street address by SMS	11
6.13 Location based service (LBS).....	12
6.14. Voice Monitor	12
6.15.Data logging.....	13
6.16. Data Load	14
6.17. Forward the third parties' message.....	14
6.18. Charges Inquiry	14
6.19. Alarm Function	15
6.19.1 Low battery alarm	15
6.19.2 External Power off alarm	15
6.19.3. GPS blind Spot alert	15
6.19.4 SOS	16
6.19.5 Geo-fence	16
6.19.6 Multi-area management.....	17
6.19.7 Movement alarm	18
6.19.8 Over speed alarm	18
6.19.9 ACC working alarm.....	19
6.20 Cut off the Oil and Power System	19
6.21Function of Remote Controller (Option for model D)	20
6.22 Arm	20
6.23Silent Mode.....	21
6.24 DISARM	21
6.25 Alarms under Arm State	22

6.25.1	ACC alarm	22
6.25.2	Shock Sensor alarm	22
6.26	Alarm without GSM network service.....	23
6.27	Sleep Mode.....	23
6.27.1	Sleep by time.....	23
6.27.2	Sleep by shock sensor.....	23
6.27.3	Deep Sleep by Shock Sensor.....	23
6.27.4	No sleep mode.....	24
6.28	Scheduled wake-up.....	24
6.29	Check IMEI	24
6.30	Check the Vehicle State	24
6.31	Reset Hardware	25
6.32	Set up Terminal (local) Time.....	25
6.33	TCP / UDP Switch	25
6.34	Configure parameters by USB	26
6.35	GPRS setting	26
6.35.1	Setting up APN.....	26
6.35.2	GPRS User ID and password Setup.....	27
6.35.3	IP and port setup.....	27
6.36	Less GPRS traffic	28
6.37	Modes Switch between “SMS” and “GPRS”	28
6.38	Set up monitor center number.....	28
6.39	Web platform and PC installation tracking software user manual	29
7	Cautions	30
8	Faults & the Solutions.....	30

1. Summary

1.1 This tracker is based on the GSM / GPRS network and GPS satellite positioning system, which sets multiple functions of security, positioning, monitoring surveillance, emergency alarms and tracking in its entirety. It can track and monitor remote target by SMS or internet.

1.2 Features

1.2.1 IP Rating: IP66

1.2.2 Internal GPS&GSM antenna, compact, elegant appearance

1.2.3 Support GPS and LBS (Location based service) double tracking solutions.

1.2.4 Support SMS/GPRS/Internet Network data transmission (GPRS/Internet instructions includes in CD in package)

1.2.5 Support configure the settings remotely

1.2.6 Sets multiple functions of security, tracking, monitoring surveillance, emergency alarms and management in its entirety

2. Applications

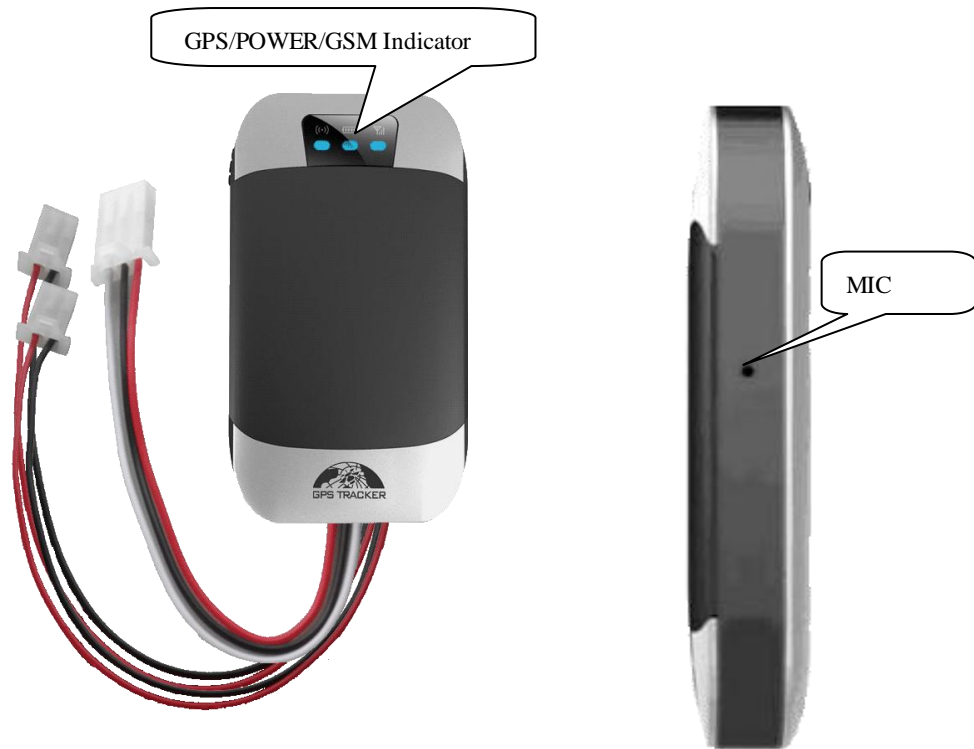

Used widely for person, vehicle and other moving object tracking.

3. Hardware Description

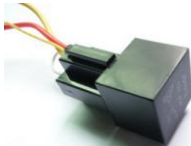

4. Accessories

Type D: Add remote controller to ARM & DISARM on the basis of type C

No.	photo	Name	Specifications	Applicable model
1		Harness	8PIN	Standard
2		Relay	12V/40A or 24V/40A	Standard
3		Small alarm siren	12V/24V	Optional
4		Remote Controller		Optional for type D

5. SPECIFICATIONS

Content	Specification
---------	---------------

DIM	8.9×5.0×1.6cm
Weight	65g
Network	GSM/GPRS
Band	850/900/1800/1900Mhz
GPS sensitivity	-159dBm
GPS accuracy	5m
GPS start time	Cold status 45s Warm status 35s Hot status 1s
Car power supply	12 V -24V
Back up battery	Chargeable 3.7V 500mAh Li-ion battery
Storage Temp	-40 ℃ to +85 ℃
Operation Temp.	-20 ℃ to +65 ℃
Humidity	5%--95% non-condensing

6. Usage

6.1 Terminal Installation

6.1.1 Please ask the qualified engineers to install it

6.1.2 Do not install it in an environment which is over GSM performance index

6.1.3 Please put SOS button at the place driver can touch

6.1.4 Connect the wires with the original car circuit showing below:

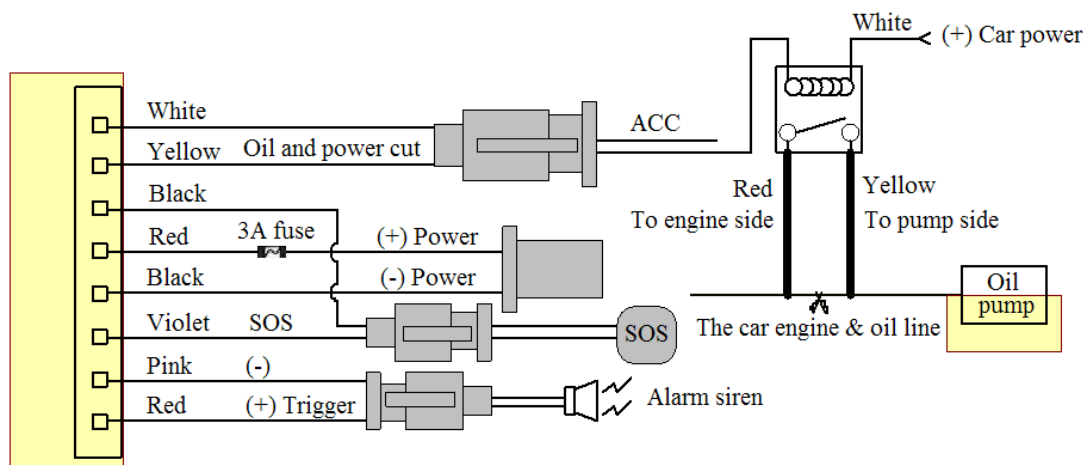

Wiring diagram

6.2 SIM CARD Installations

6.2.1 Use the screwdriver accompanied with the device to open sealed buckle and insert the SIM card. If need data logging function, please insert microSD and put sealed buckle back

6.2.2 Please make sure the SIM card is for GSM network and able to execute the function of incoming calls display, no calls can be diverted and the PIN code is locked. The SMS format must be TXT format, and can't recognize the PDU format

6.3 Turn on the Tracker Device.

Connect the positive & negative wire, red & black ones, with 12V or 24V car power system, wait for 1 minute after connecting power to wait tracker works normal, and then turn on the backup battery switch.

6.4 GSM/GPS LED Indicator

Red LED: when charging, LED ON, After full charged, LED OFF,
In Low power, LED flash fast.

Green LED: In GSM Mode, LED quick flash for each second, In GPRS Mode, LED flash one time in three seconds, when No GSM reception, LED ON.

Blue LED: In good GPS reception, LED quick flash for each second,
No GPS reception, LED OFF.

6.5 Initialization

Send "begin+password" in SMS to the unit, it will reply "begin ok" and initialize all the settings. (Default password: 123456)

For example, send SMS "begin123456" to the tracker via a cell phone, if succeeded, it will reply "begin ok".

6.6 Change Password

6.6.1 Send SMS “password+old password+space+new password” to the unit to change the password.

For example: send SMS “password123456 888888” to the unit. If succeeded, “password ok” will reply to your cell phone from the device tracker.

6.6.2 Be sure to keep the new password in mind, you have to upload the software to restore the original setting in case of losing the new password.

6.6.3 Attention: Make sure the new password is in 6 digits Arabic numbers, or else the tracker cannot recognize the password.

6.6.4 The “+” in the command, please don’t type “+”, space means press the space keyboard on your cell phone

6.7 Authorization

There are 5 numbers to be allowed to authorize in the tracker at most.

6.7.1 Call the tracker for 10 times continuously and get position correctly, then it will make the cell phone number as the authorized number automatically, and reply “add master ok”.

6.7.2 Authorization Send SMS: “admin+password+space+cell phone number” to set up a authorized number. The other authorized numbers should be set by the first authorized number. If the number is successfully authorized, the unit will reply “admin ok!” in SMS.

6.7.3 Delete authorization Send SMS: “noadmin+password+space+authorized

number” to delete the authorized number.

6.7.4 For roaming purpose, you have to add your country code ahead of the cell phone number, for example, please send: “admin123456 +8613322221111” to tracker to set 13322221111 as an authorized number.

6.8 Single Locating

6.8.1 Any number calls the tracker device; it will reply a SMS including the position of latitude and longitude if authorized number is not set. If authorized number has been set successfully, the device won't reply SMS including the positioning of latitude and longitude when the unauthorized number dials up it.

6.8.2 Dialing the tracker device from the authorized number, it will hang up your calling and respond to a real-time latitude and longitude information as following:



***Tracking location** When no GPS signal, the SMS includes the last valid latitude & longitude as well as the LAC code of current position, the LAC code can be input in the column of “manual track” menu of web platform to check location.

6.9 Auto track continuously

6.9.1 Track with limited times upon time interval:

Send SMS command “fix030s005n +password” to the tracker device, it will report the latitude & longitude at intervals of 30 seconds for 5 times. (s:second, m:minute, h:hour). This command set must be in 3 digits and the maximum value is 255.

6.9.2 Track with unlimited times upon time interval:

Send SMS “fix030s***n+password” to the tracker device, it will reply the latitude & longitude continuously at interval of 30 seconds.

Note: the interval must not less than 20s.

6.9.3 Smart track upon time and distance interval:

6.9.3.1 Please set "track with unlimited times upon time interval" before this function, and send "distance+password+space+distance", tracker will reply "Distance ok", and then tracker will locate upon both the pre-set time and distance.

E.G: Send "distance123456 0050", it means distance is 50 meters; the number must be 4 digits Arabic numbers.

6.9.3.2 Set this function on web server: Set time interval first and then distance interval, tracker will locate upon the time and distance.

6.9.4 Cancel: Send SMS “nofix+password” to the tracker device to cancel the “auto track”.

6.10 Automatic update positions of vehicle turns

6.10.1 The tracker will update the positions automatically to web server once the vehicle changing driving direction over pre set angle value to form a smooth trajectory consistent with the actual road, this function is only effective in GPRS mode.

6.10.2 Send "angle+password+space+angle" to tracker, it will reply" angle ok".

6.10.3 The angle must be 3 digits Arabic numbers, default angle value is 30 degree.

6.11 GPS drift suppression

6.11.1 This function is deactivated as default, send "suppress+password" to tracker, it will reply" suppress drift ok". The GPS data stop updating if vehicle is not driving (ACC is OFF) and latitude and longitude always keep same, and GPS data updates automatically when vehicle is moving.

6.11.2 Cancel: send "nosuppress+password" to tracker, it will reply" nosuppress ok ".

6.12 Absolute street address by SMS

6.12.1 You must set up the APN of your local GSM network for the SIM card in tracker first before using this function, if there is user name and password for GPRS login, (Please refer to 6.35 to configure the APN, user name and password for GPRS login.)

6.12.2 After configure the APN, send "address+password" to device, it will reply SMS including real street/address name. For example: No.113, Guankou 2nd Rd, Nantou, Nanshan district, Shenzhen, Guangdong, china.

6.13 Location based service (LBS)

When the tracker device doesn't receive valid GPS signals, tracker will positioning by location based service(LBS), the messages includes the GPS coordinates of the last position in SMS mode, but the LAC in message is the current new position, the location can be seen by input the LAC code in the menu "Manual Track" of web platform www.gpstrackerxy.com, you can also send command "address+password" to tracker to get the newest absolute address and GPS coordinates as well; tracker will automatically switch to track by location based service in GPRS mode, and actualized on the map of web server with LBS mark. And there may be some inaccuracy with actual location by LBS tracking; the bias depends on GSM reception.

Note: This feature can be used normally in most areas according to the signal of GSM network. It may not be available in some areas.

6.14. Voice Monitor

6.14.1 The command to switch between Track and Monitor mode are "tracker" and "monitor".

6.14.2 The default mode is “track” (Track mode).

6.14.3 Send SMS “monitor+password” to the unit, and it will reply “monitor ok!” and switch to “monitor” mode.

6.14.4 Send SMS “tracker+password” to the unit, it will reply “tracker ok!” and restore to “track” mode.

6.15.Data logging

6.15.1 When the tracker device loses GSM signals or fall offline from GPRS, tracker will store the tracking position and alerts automatically upon the pre-set condition, when GSM signals get back, all the event alerts will be auto-sent to the authorized numbers or monitoring platform (server), but the stored tracking data should be loaded to the monitoring platform via SMS command.

6.15.2: Storage upon times: Send SMS: “save030s005n+password” to the tracker unit, it will reply “save ok”, and store the lat, long locations every 30 seconds for 5 times. (S: second, m: minute; h: hour).

6.15.3 Unlimited storage: Send sms:”save030s***n+ password” to tracker device, it will reply “save ok”.

6.15.4: Storage Clearance: Send SMS: “clear+ password” to tracker device, it will reply “clear ok”.

6.15.5: Storage Volume: It depends on the capacity of the SD card inserted in the tracker device.

6.15.6: The stored data in SD card can be copied to computers through card reader, and then the data route can be checked by importing data in the menu “Data Import” of web platform www.gpstrackerxy.com

6.16. Data Load

6.16.1 Current date Load: Send SMS: "load+ password" to tracker device, it will reply: "load ok" if the device is working well under GPRS mode; if not, it will reply "load fail! Please check gprs" that means device does not work under GPRS mode. Data can only be loaded to monitoring platform by GPRS.

6.16.2 Specified date Load: Send SMS: "load+ password+ space+ year month date" to tracker device, it will reply: "load ok" .For Example: send SMS: "load123456 20110425" to the tracker device, means to load the tracking data of 25th April 2011 to monitoring platform.

6.17. Forward the third parties' message

6.17.1 Send SMS "forward+password+space+third parties phone number" from authorized phone number, tracker will reply"forward ok", and supports 1 third parties phone numbers at most.

For example, set the phone number of the service provider of the sim card in the tracker, when charge remind message coming in, tracker will forward it to authorized phone number.

6.17.2 Cancel: Send SMS command "noforward+password".

6.18. Charges Inquiry

Send SMS command "balance+password+space+carrier's phone

number+space+code" to tracker, it will forward the code to carrier's phone number and return the balance message received from carrier's phone number.

6.19. Alarm Function

6.19.1 Low battery alarm

6.19.1.1. Send SMS "lowbattery+password+space+on", it will send SMS "low battery+latitude/longitude" to authorized numbers 2 times in total in **15 minutes interval** when voltage of battery is going to be about 3.55V.

6.19.1.2 This function activates as default, send SMS "lowbattery+password+space+off" to deactivate.

6.19.2 External Power off alarm

6.19.2.1 Send " extpower+password+space+on" to activate, it will send SMS "power alarm+latitude/longitude" to authorized numbers every 3 minutes when external power is cut off.

6.19.2.2 Cancel: Send SMS " extpower+password+space+off" to deactivate it.

6.19.3. GPS blind Spot alert

6.19.3.1 This function deactivates as default, send SMS "gpssignal+password+space+on", it will send alert SMS "no gps+last valid latitude/longitude before lose signal"

6.19.3.2 Send SMS "gpssignal+password+space+off" to deactivate.

6.19.4 SOS

Long Press the SOS button for 3 seconds (For model D, press  button on remote controller for 3 seconds) , the tracker device will send SMS “help me!+lat./long.” to all the authorized numbers at interval of 3 minutes. It will stop sending such alert SMS when any authorized number reply SMS “help me” to the tracker.

6.19.5 Geo-fence

Set up a geo-fence for the tracker device to restrict its movements within a district. The unit will send SMS to the authorized numbers when it goes out of this district.

Set up: When the unit stays immobile in a place for 3-10 minutes, the user can send

SMS“stockade+password+space+latitude,longitude;latitude,longitude” to unit to set the restricted district. In case of breach, it will send SMS “stockade!+ latitude & longitude” to the authorized numbers

Remark: The first latitude & longitude is coordinate of the top left corner of the Geo-fence, while the second latitude & longitude is the coordinate of the bottom right corner, it will alarm at interval of 3 minutes.

Cancel: Send SMS “nostockade+password” to deactivate this function.

6.19.6 Multi-area management

6.19.6.1 Set Area

Send SMS command

"area+password+space+latitude,longitude+space+areaname,distanceM" to tracker(distance unit: M for meter, K for kilometer), it will reply "area01 ok".

Example: Send "area123456 22.353648,113.543678 school,800M".

Note: 5 areas at most and the distance between two points can't be less than the total distance in the 2 commands, and different areas can't cover each other.

6.19.6.2 Delete areas

Send SMS command:"noarea+password+space+area name", tracker will reply:"noarea ok".

6.19.6.3 Rename and set distance

Send SMS command "rename+password+space+old name;new name,distanceM" to tracker, if name is not repeated and area doesn't cover others, it will reply "rename ok!" for successful configuration.

Example: Send " rename123456 Area01;school,800M ", it means the new area name is "school", and covers area of a radius of 800 meters.

6.19.6.4 Activate multi-area management

Send SMS command "area+password+space+on" to tracker, it will reply "Area on ok!", when tracker enters the pre set area, it will send SMS "area

name+latitude & longitude" to all the authorized phone number, and send same SMS when goes out of the area.

6.19.6.5 Deactivate Multi-area management

Send SMS command "area+password+space+off" to tracker, it will reply"area off ok!"

6.19.7 Movement alarm

6.19.7.1. Set up: when the unit stays immobile in a place for 3-10 minutes with

GPS signal reception, the user can send

SMS“move+password+space+0200” to the tracker (Suppose area of a

radius of 200 meters, it supports 4 digits at most. Unit: Meter). It will

reply “move OK”. In case of such a movement (the default distance is

200m), it will send SMS “Move+ latitude & longitude” to the authorized

numbers at interval of 3 minutes.

6.19.7.2 Cancel: Send SMS “nomove+password” to deactivate the movement alarm.

6.19.8 Over speed alarm

Set up: Send SMS “speed+password+space+080” to the unit (suppose the speed is 80km/h), and it will reply “speed OK!”. When the target moves exceeding 80km/h, the unit will send SMS “speed+080!+ latitude & longitude” to the authorized numbers at interval of 3 minutes.

Cancel: Send SMS “nospeed+password” to deactivate the overspeed alarm.

Remark: The recommended speed should be not less than 30km/h. For below that rate, it will be effected the accuracy by GPS signals drift etc.

6.19.9 ACC working alarm

6.19.9.1 This function is disabled as default. To active this function, send "ACC+password" to tracker, it will reply "ACC ok". And tracker will send "ACC on+latitude & longitude" to authorized numbers when detect ignition action, that means the vehicle has been started; and tracker will send “ACC off+latitude & longitude" to authorized numbers, that means ACC off.

6.19.9.2 Send "noACC+password" to disabled this function, tracker will reply "noACC ok".

6.19.9.3 This configuration can only enable and disable the alarm to authorized numbers; it will send to web server automatically in GPRS mode and can't be disabled.

6.20 Cut off the Oil and Power System

6.20.1 Send command “stop+password” to tracker, tracker will execute it and reply “Stop engine Succeed”. And it will remain immobile state until next command to resume.

6.20.2 Stop mode

6.20.2.1 Execute immediately: Send command “quickstop+password” to tracker, it will reply “quickstop OK”. Then tracker will stop the car immediately after “stop” command.







6.20.2.2 Execute depends on speed(Default mode): Send command “noquickstop+password” to tracker, It will reply “noquickstop OK”, Then the tracker won't stop the car immediately

after “stop” command, instead, will reply “it will be executed after speed less than 20KM/H”, and stop the car when the speed is less than 20KM/H

6.20.3 Resume the Oil and Power System

send “resume+password” to tracker, it will reply "Resume engine succeed", that means vehicle has resume the oil supply.

6.21 Function of Remote Controller (Option for model D)

Button	Function	Descriptions
	ARM	Press for 0.5 second, the siren will beep one time.
	DISARM	Press for 0.5 second, the siren will beep two times.
	ARM & Silent mode	Press for 0.5 second when it is in disarm state, the siren will beep one time. No voice from siren when alarm triggered and quit from siren mode automatically when disarm.
	SOS	Press for 3 seconds, Tracker will send SOS alert to authorized phone numbers without voice.
	Deterrence/car search	Press for 0.5 second when it is in arm state, siren will beep 10 seconds, press disarm button  to quit.

6.22 Arm

6.22.1 Set up arm by SMS

Send “arm+password” to tracker, it will make the car enter ARM states and and reply “Tracker is activated”.

If the car is in ignition (ACC is at “ON” position), then the car can’t enter ARM state, reply “set up fail! pls turn off ACC”.

6.22.2 Set up arm by remote controller (Option for model D)

Press  button on the remote controller for 0.5 seconds, the car enters armed state and the siren will beep one time, no SMS reply.

If the car is in ignition (ACC is at “ON” position), then the car can’t enter ARM state, and siren keep silent.

6.23 Silent Mode

6.23.1 Set up silent mode by SMS

Send `silent+password` to tracker, it will reply `silent ok!` that means tracker enters ARM & silent mode, Siren won’t sound after alarm is triggered, but tracker will send alarm SMS to authorized number.

Send `disarm+password` to quit ARM & silent mode.

6.23.2 Set up silent mode by remote controller (Option for model D)

Press  in disarm state for 0.5 second, the siren will beep one time, the car will enter ARM & Silent mode. Siren won’t sound after alarm is triggered, but tracker will send alarm SMS to authorized numbers.

Press  to quit.

6.24 DISARM

6.24.1 DISARM BY SMS

Send command “disarm+password” to tracker, tracker will disarm and reply “Tracker is deactivated”, then it will turn off the alarm of shock sensor and ACC, and no alarms if trigger shock sensor and ignition.

6.24.2 DISARM BY Remote controller (Option for model D)

Press  on remote controller for 0.5 seconds, the car will enter DISARM state, siren beeps two times and tracker doesn’t send message.

6.25 Alarms under Arm State

6.25.1 ACC alarm

The unit will send SMS “ACC alarm+lat/long” to the authorized number at interval of 3 minutes when the engine of the car is turned on, that is the key is rotated to ACC.ON position to start the car in arm state; Siren will sound for 30 seconds, send “disarm+password” to stop it

6.25.2 Shock Sensor alarm

6.25.2.1 The unit will send SMS “Sensor alarm+lat/long” to the authorized number when the sensor is triggered in arm status; send “disarm+password” to stop it.

6.25.2.2 Shock sensor sensitivity configuration

The sensitivity of the built-in shock sensor has three different level:

First level: Alarm will be triggered after detect slight vibration, send command" sensitivity+password+space+1" .

Second level: Alarm will be triggered after detect 8 times vibration in 2 seconds, send command" sensitivity+password+space+2".

Third level: Alarm will be triggered after detect 25 times vibration in 5 seconds, send command" sensitivity+password+space+3".

6.26 Alarm without GSM network service

When the car is in the place without GSM network service, siren will sound under non-silent mode if alarm is triggered (sensor, ACC), but no SMS alarm will be sent to authorized number.

6.27 Sleep Mode

6.27.1 Sleep by time

Send SMS command "sleep+password+space+time" to tracker device, tracker will reply "sleep time ok" if none of the alarms has been set and no operations, tracker will fall asleep in 5 minutes, GPS module shuts down, LED will be off ,calling or SMS can awake the tracker. If these alarms have been set, tracker will sleep by detecting shock sensor.

6.27.2 Sleep by shock sensor

Send SMS command "sleep+password+space+shock"to tracker device, tracker will reply "sleep shock ok", it will enter sleep mode if no shake is detected , GPS module shuts down, LED will be off . Shake or any operation can awake the tracker

6.27.3 Deep Sleep by Shock Sensor

Send "sleep+password+space+deepshock", tracker will reply "sleep deepshock ok" it will enter sleep mode if no vibration detecting, Tracker will be in super low power consumption status with GPS & GSM module shut off, and LED off.

Calling or SMS can't awake the tracker .Alarms can be triggered and work normally. The unit will resume to deep sleep by shock sensor mode once alarms stop

6.27.4 No sleep mode

Send SMS command"sleep+password+space+off" to tracker device, tracker will reply"sleep off ok". Tracker won't sleep and GSM, GPS, LED will work.

This mode is the default mode.

6.28 Scheduled wake-up

Send SMS command"schedule+password+space+1h"to GPS unit, tracker will wake up each hour and report location (m: minute, h: hour, d: day) the maximum interval at most is 3digital, and not more than 30 days.After setting this command, Tracker will be in super low power consumption status with GPS & GSM module shut off, and LED off. Calling or SMS can't awake the tracker .Alarms can be triggered and work normally. The unit will resume to scheduled wake-up mode once alarms stop

Cancel scheduled wake-up: After wake up, send sms"nonschedule+password", this function can be canceled

6.29 Check IMEI

Send SMS command "imei+password" to the unit. E.g. Send SMS command "imei123456" to the tracker device, an IMEI number of 15 digits will reply to your cell phone.

6.30 Check the Vehicle State

Send SMS command "check+password" to the tracker device in the vehicle, It will reply the status of the power, battery, GPS,&GSM signal, GPRS status to

the authorized numbers.

For example: Send SMS “check123456” to the tracker device in the vehicle, It will reply following SMS.

Power: ON/OFF

Battery: 100%

GPRS: ON/OFF

GPS: OK/NO GPS

GSM Signal: 1-32 The higher digit it shows; the stronger of GSM signals it receives.

6.31 Reset Hardware

Send SMS “reset+password” to tracker device, it will reply “reset ok”. And the GSM module and GPS module in the tracker will be reset

6.32 Set up Terminal (local) Time

6.32.1 Send SMS command “time+space+zone+password+space+time” to the tracker unit, If succeed, It will reply “time OK”

6.32.2 For example: Send SMS “time zone123456 8”, 8 is Chinese time zone, If your country time zone is minus, send SMS “time zone123456 -8”.

6.33 TCP / UDP Switch

Send command: "gprs+password,0,0" switch back to TCP mode, this is the default mode.

Send command: "gprs+password,1,1" switch to UDP mode.

6.34 Configure parameters by USB

Connect the gps tracker to computer with the optional USB cable, find gps tracker's internal memory and open serial debugging tool  user_config.ini in the format of text, edit the commands according to the tips. .

Note: Filling password correctly is required to configure parameters by USB successfully.

6.35 GPRS setting

User must send SMS via cell phone to set up IP, port and APN before starting GPRS.

6.35.1 Setting up APN

6.35.1.1 APN standards for Access Point Name and differs from country to country. For more information about the local APN, inquire with your local GPRS network operator.

6.35.1.2 Text the tracker a SMS "APN+password + Space + your local APN" via a cell phone and if setup successfully, the tracker will return the message "APN OK".

6.35.1.3 e.g. send SMS command "APN123456 CMNET". If succeeded, "APN OK" is returned by the tracker in SMS.

Notes: 123456 refer to password of tracker and CMNET is the APN of China Mobile (One of GSM Operator in China).

6.35.2 GPRS User ID and password Setup

6.35.2.1 In most countries, the user name and password involving GPRS login are not compulsorily necessary, therefore, the entry can be skipped. For those countries requiring user name and password, please configure as following

6.35.2.2 Send SMS “up+password+space+user+space+password” If succeeded, “user,password ok” is returned by the tracker in SMS”

6.35.2.3 For instance, send SMS “up123456 jonnes 666666” to the tracker, and if succeeded, the tracker returns “user, password OK”

Note: 123456 is tracker device password, jonnes is the user name for GPRS login, 666666 is the password for GPRS login.

6.35.3 IP and port setup

6.35.3.1. Send SMS as below via a cell phone: adminip +password + Space + IP Address + Space + Port Number. If succeeded, “adminip OK” is returned by the device in SMS.

6.35.3.2 e.g, Send SMS command “adminip123456 202.104.150.75 9000” to the tracker device, If succeeded, “adminip OK” is returned by the device in SMS.(123456 is default password, 202.104.150.75 is IP, 9000 is port).

6.36 Less GPRS traffic

6.36.1 Tracker will change to less GPRS traffic mode after parking 5 minutes, GPRS disconnect and connect again when alarm being triggered or vehicle starts driving.

6.36.2 Activate this function: Send "less gprs123456 on", tracker will reply "less gprs on ok".

6.36.3 Deactivate this function: Send "less gprs123456 off", tracker will reply "less gprs off ok".

Note: 123456 is the password of tracker, and replace it with the new if you have changed.

6.37 Modes Switch between "SMS" and "GPRS"

6.37.1 The default mode is "SMS"

6.37.2 Send SMS "GPRS+password" to the unit, and it will reply "GPRS ok!" it means tracker device has switched to "GPRS" mode.

6.37.3 Send SMS "SMS+password" to the unit, it will reply "SMS ok!" and restore to "SMS" mode.

6.38 Set up monitor center number

6.38.1 Setup: send command "centernum+password+space+number" to tracker, it will reply "centernum ok". After setup monitor center number, the messages of auto track by sms will be set to this center number, if all alarms need to be sent to this number too, then this

center number must be setup as authorized number

6.38.2 Cancel: Send “nocenternum+password” to tracker, it will reply “no center num ok”.

6.39 Web platform and PC installation tracking software user manual

6.39.1 Web based platform www.gpstrackerxy.com. Configuration IP: 202.104.150.75 Port: 9000. Please check “software platform user manual” included in the CD for detailed operation information.

6.39.2 PC based installation tracking software user manual included in the CD in package.

7 Cautions

Please comply with the instructions to extend the unit life: :

1. Keep the unit dry. Any liquid, i.e. rain, moisture, may destroy or damage the inside circuitry.
2. Don't use & store the unit in dusty places.
3. Don't put the unit in overheated or overcooled places.
4. Handle carefully. Don't vibrate or shake it violently.
5. Clear the unit with a piece of dry cloth. Don't clean in chemicals, detergent.
6. Don't paint the unit, this may cause some foreign materials left in between the parts.
7. Please read the user manual carefully before installation and operation, learn something more about the voltage range. Otherwise, it won't work properly or destroy the product.

8 FAULTS & THE SOLUTIONS

Faults	Solution
Fail to turn on	Please check out the power wiring in correct place.
No GSM Signal	Please make sure SIM Card is GSM Net and installed correctly; also call display should be on; but no call transfer and PIN code off.
No GPS Signal	A more open view of the sky recommended to make sure the device can receive the GPS signal normally.

SMS reply fail	Password incorrect or wrong sms commands format
Call without SMS reply or cannot receive alarm SMS	Authorized number is wrong or without setting any authorized number
Remote Controller fail	Remove external power , turn on the device and program again
Siren fail	Siren's voltage is DC12V/24V/1A. Siren can't be activated if it is negative triggered.